

CITYCON  
SCREEN  
MEDIA

**Screen media guide** for advertising in the  
commercial areas in Citycon shopping centres



# BASIC GUIDELINES

## Ready content

- The material must be delivered 3 days before campaign starts.
- The material must be in one single file, the separation between screens will be done by the operator.

### Screens

- No audio
- Borderless

### Video

- MP4/h264
- min. 12mbit/s CBR
- 25fps progressive

### Still

- JPEG/PNG
- 72dpi
- RGB

## ESA Digital production

- The material must be delivered 5 days before campaign starts.
- Elements in vector and/or high resolution.

# CITYCON SCREEN MEDIA



## FORUM Jyväskylä 5 screens

### FULL

- 16:9
- 1920 px x 1080 px
- 4 x 55"
- 2486 mm x 1450 mm
- LCD

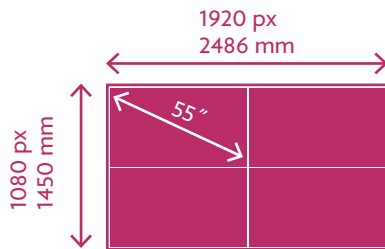

### BANNER 4 x 1 (2 pcs)

- 64:9
- 7680 px x 1080 px
- Upstairs**
  - 4 x 55"
  - 4972 mm x 725 mm
- Downstairs**
  - 4 x 46"
  - 4240 mm x 626 mm

- LCD

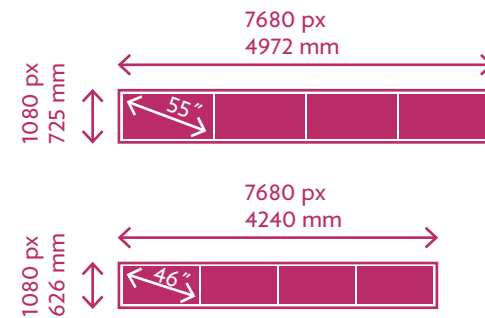

### BANNER 2 x 1

- 32:9
- 3840 px x 1080 px
- 2 x 55"
- 2486 mm x 725 mm
- LCD

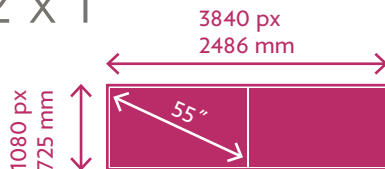

### ENTRANCE

- One single video file
- Divided in the middle
- 448 px x 320 px
- 2 x 1344 mm x 2304 mm
- LED

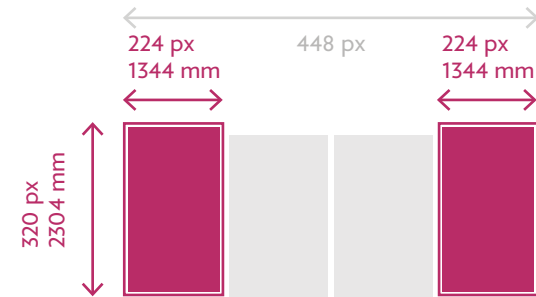

# CITYCON SCREEN MEDIA



## ISOKARHU Pori 7 screens

### FULL (3)

- 16:9
- 1920 px x 1080 px
- 2 x 55" back to back
  - 1243 mm x 725 mm
- 1 x 65"
  - 1451 mm x 840 mm
- LCD

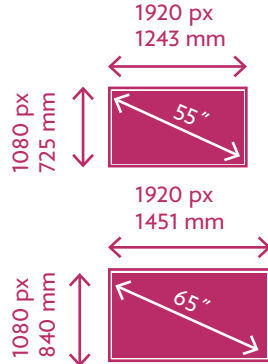

### CORNER

- 0,38:1
- 128 px x 336 px
- 960 mm x 2400 mm
- LED
- Two separate videos

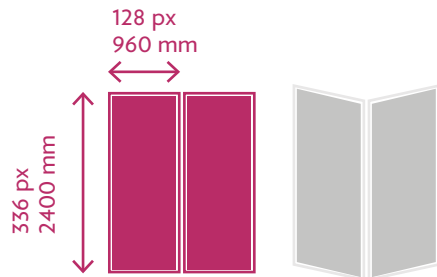

### ENTRANCE

- Entrance crop
- 1,68:1
- 832 px x 496 px (hole 448 px x 368 px)
- 4992 mm x 2976 mm  
(hole 2688 mm x 2208 mm)
- LED
- Hole cut out automatically
- One single video file

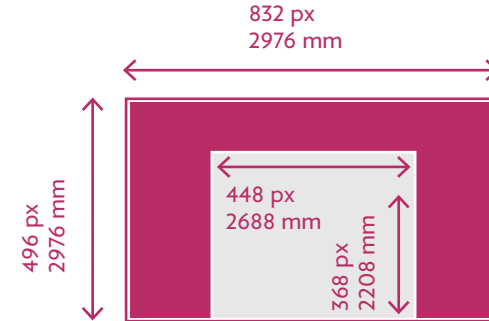

### 45DG MOSAIC

- APRX 16:9
- 3840 px x 2160 px upscaled  
(5400 px x 3600 px ideal size)
- LCD

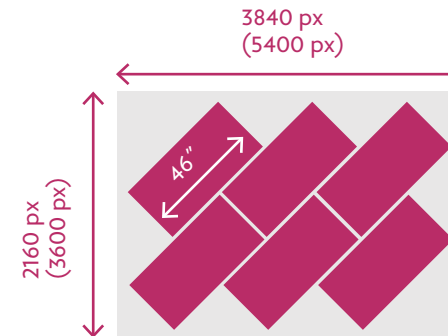

# CITYCON SCREEN MEDIA



## ISOKRISTIINA Lappeenranta 3 screens

### INDOOR (2)

- 2:1
- 480 px x 240 px
- 3000 mm x 1500 mm
- LED

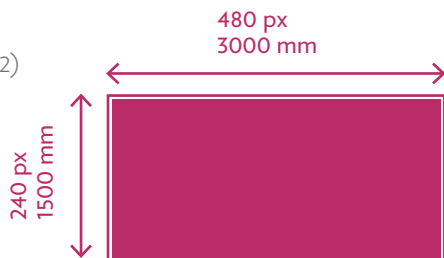

- 2:1
- 480 px x 256 px
- 2880 mm x 1536 mm
- LED

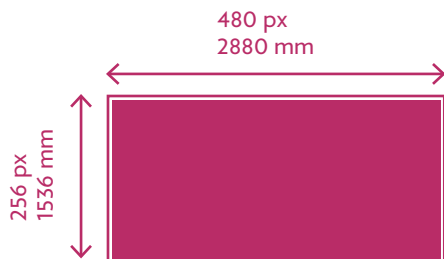

### OUTDOOR

- 0,71:1
- 320 px x 448 px
- 4480 mm x 3040 mm
- LED

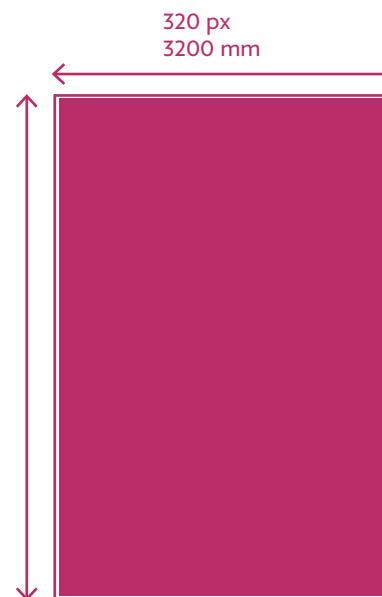

# CITYCON SCREEN MEDIA



## ISO OMENA Espoo

1/2

### U-LED

Length over 32 meters!

- full resolution 5184 px x 192 px
- left side 1536 px x 192 px
- middle 2112 px x 192 px
- right side 1536 px x 192 px

NOTE! Different format for U-LED -screen:

- MP4 H.265 (HEVC) CBR



### LED-stripe

- 1152 px x 96 px
- 7460 mm x 574 mm

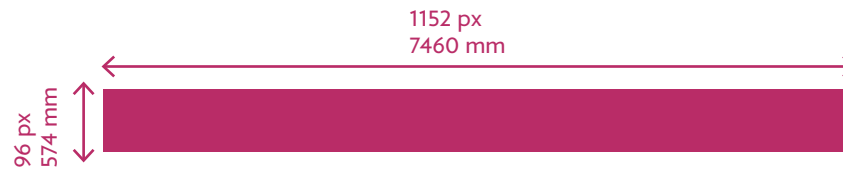

# CITYCON SCREEN MEDIA



## ISO OMENA Espoo

2/2

### ESCALATOR (2)

LCD – PORTRAIT 1 & 2

- 9:16
- 1080 px x 1920 px single screen
- 4 x 55"
- 3 x 55"
- LCD

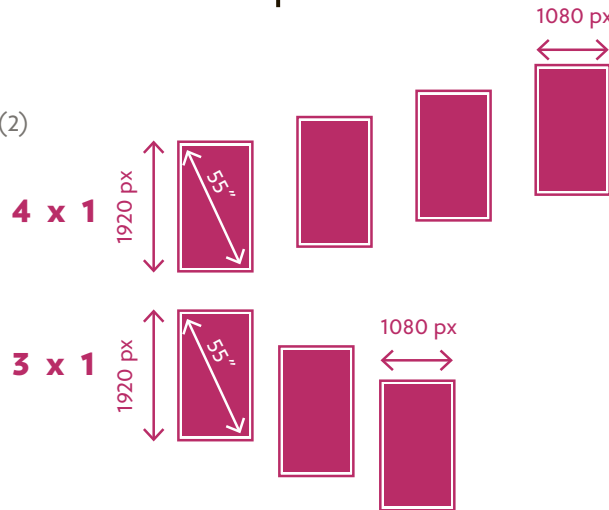

### ESCALATOR

LED – MARKETS

- 800 px x 320 px
- 3200 mm x 1280 mm

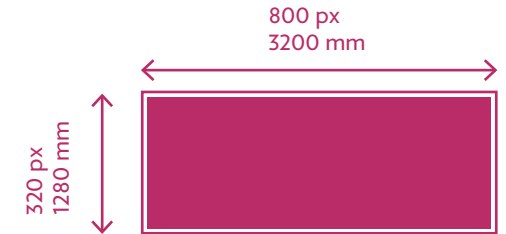

### ELEVATOR (6)

- 2 x 16:9 1920 px x 1080 px side by side
- or one large 32:9 3840 px x 1080 px
- 8 x 55"
- 5000 mm x 1440 mm
- LCD

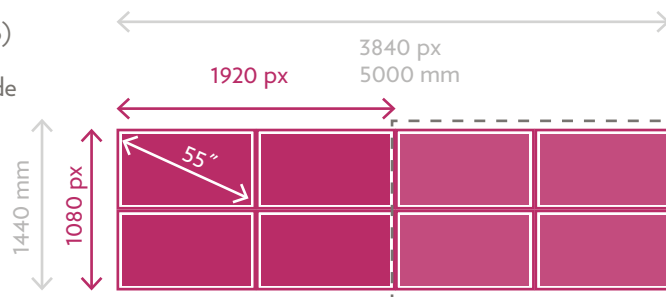

### OUTDOOR

LED

- 768 px x 480 px
- 7680 mm x 4800 mm

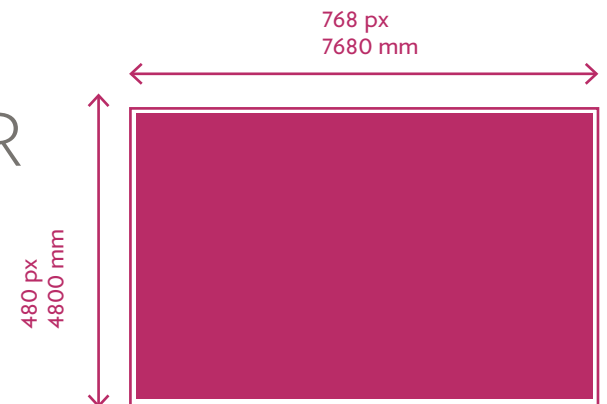

# CITYCON SCREEN MEDIA



## MYYRMANNI Vantaa 2 screens

### FULL

- APRX 16:9
- 720 px x 400 px
- 4500 mm x 2500 mm
- LED

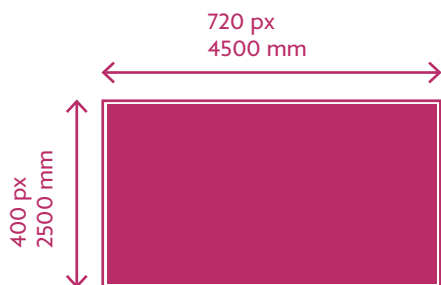



# CITYCON SCREEN MEDIA



## TIKKURI Vantaa

1 screen

### FULL

- 16:9
- 1920 px x 1080 px
- 4 x 55"
- 2486 mm x 1450 mm
- LCD

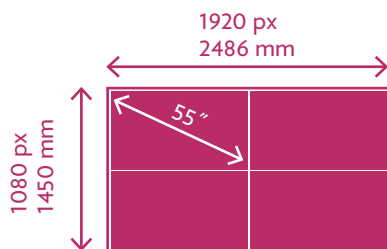

# CITYCON SCREEN MEDIA



## TRIO Lahti 2 screens

### FULL

- 16:9
- 1920 px x 1080 px
- 4 x 55"
- 2486 mm x 1450 mm
- LCD

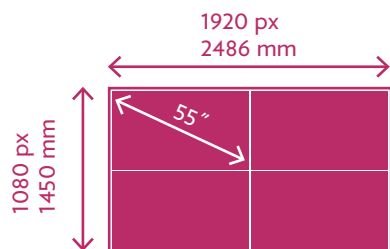

**CITYCON  
SCREEN  
MEDIA**

**Citycon screen media powered by:  DIGITAL**

**Sales:** [myynti@esadigital.fi](mailto:myynti@esadigital.fi)

**Additional info:** [tuotanto@esadigital.fi](mailto:tuotanto@esadigital.fi)